



CG JENSEN 

 VEJLE
KOMMUNE

Vejles svar på Cykelislangen

Hussein Al-Nema, CG Jensen A/S
Jesper Kjærgaard, Vejle Kommune

Dansk Brodag 9. april 2024

Hvem er vi?

Jesper Kjærgaard

Projektchef i Vejle Kommune 2020

2020 – 2012 Vejdirektoratet
Fagprojektleder udførelse.

2012-2004 COWI
Entrepriseleder udførelse.

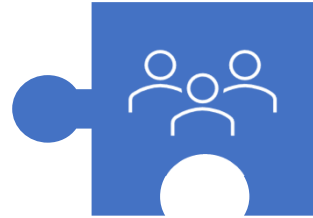

Hvem er vi?

- Hussein Al-Nema
 - Projektleder i ståldivisionen siden 2018
 - Flere end 20 stålbroer
 - Tidligere rådgivende ingeniør
 - Civilingeniør med speciale i konstruktioner, DTU 2014

CG JENSEN 



Agenda

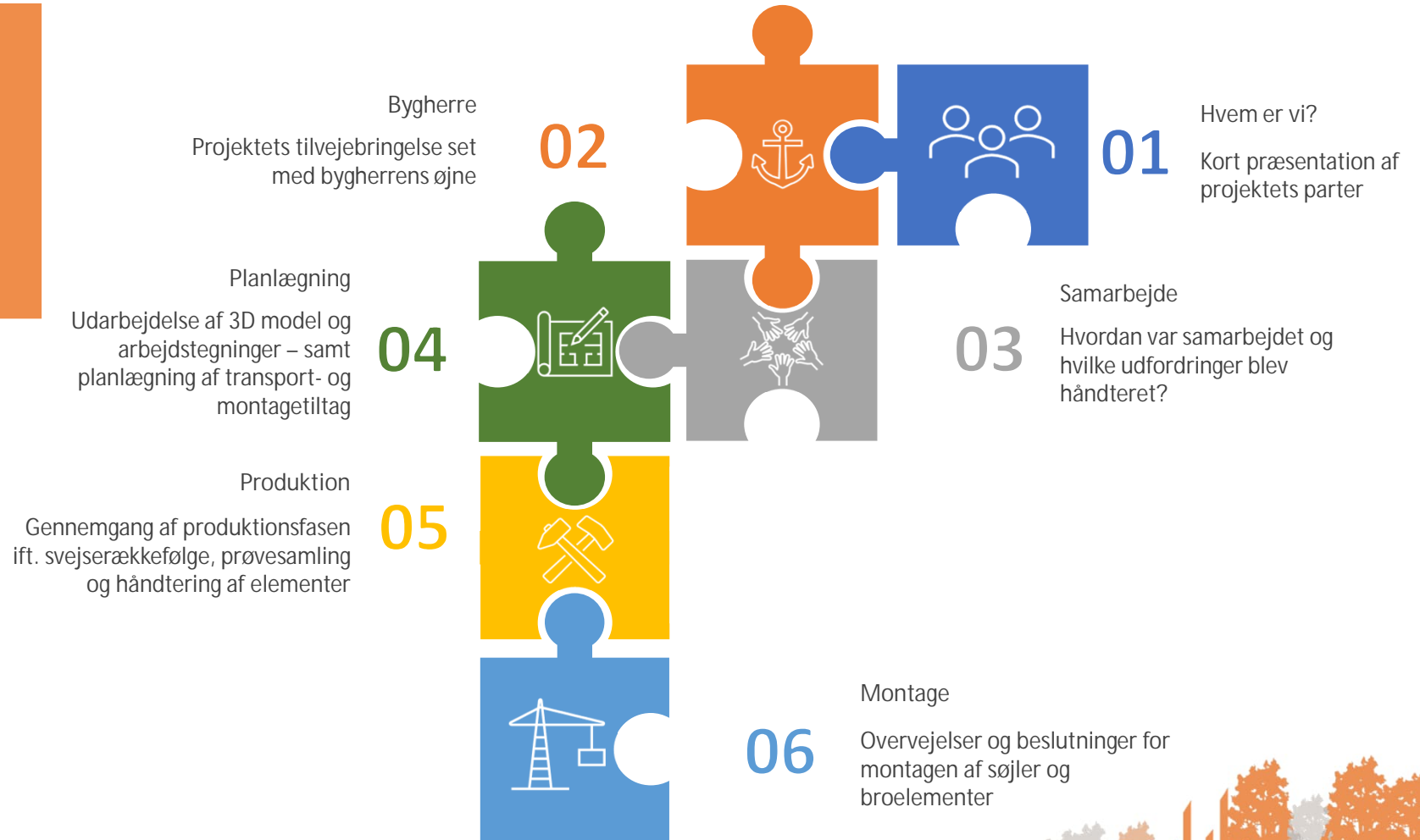

Hvem er vi?



Hvem er vi?



Arkitema ..

COWI

CG JENSEN 

Fakta - tidsplan

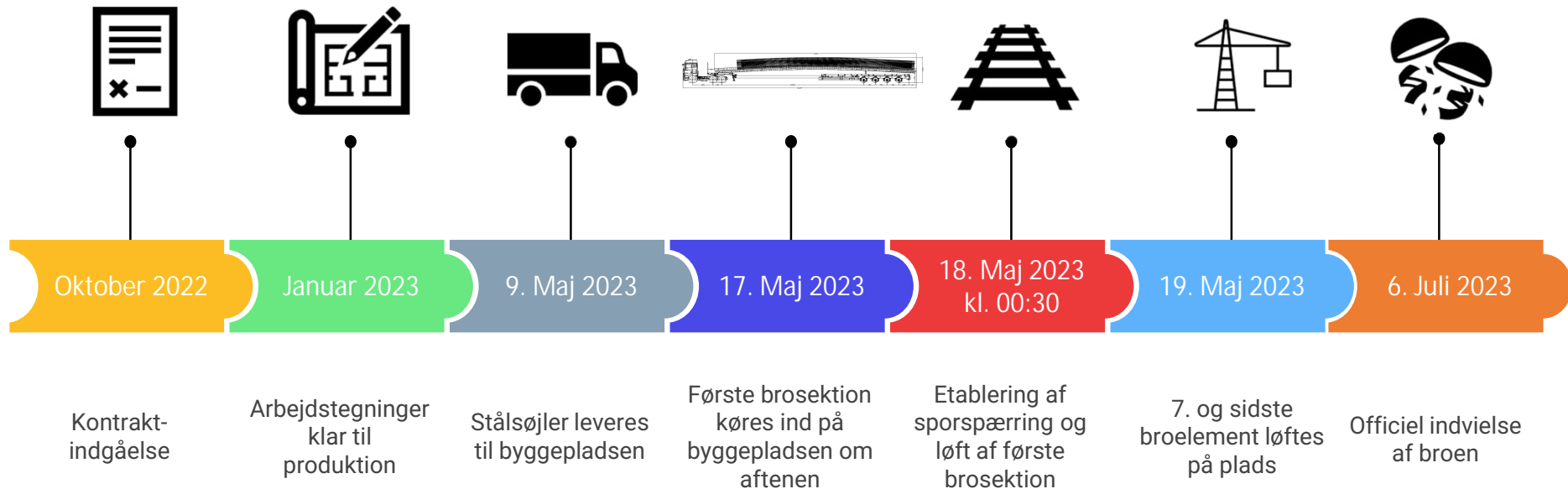
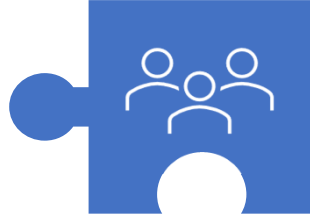

Fakta



Hvad har det kostet?

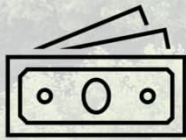

DKK 19 millioner

Fakta

- 560 lbm. stål-pæle
- 60 m³ beton
- Corten stål: 125.417 kg
- Længde 128 m
- Produktionsted: Świecie, Polen



Mobilitetsplan

- Et visionskatalog 2018-2030
- Baggrund og principper
- Nye projekter
- Handlingsplan



Vision & baggrund

- Vejle Kommunes vækst
- Attraktiv mobilitet
- Fredelig midtby
- Høring og borgerinddragelse
- Kapacitetsberegning og trafikmodeller
- Transportvaneundersøgelser

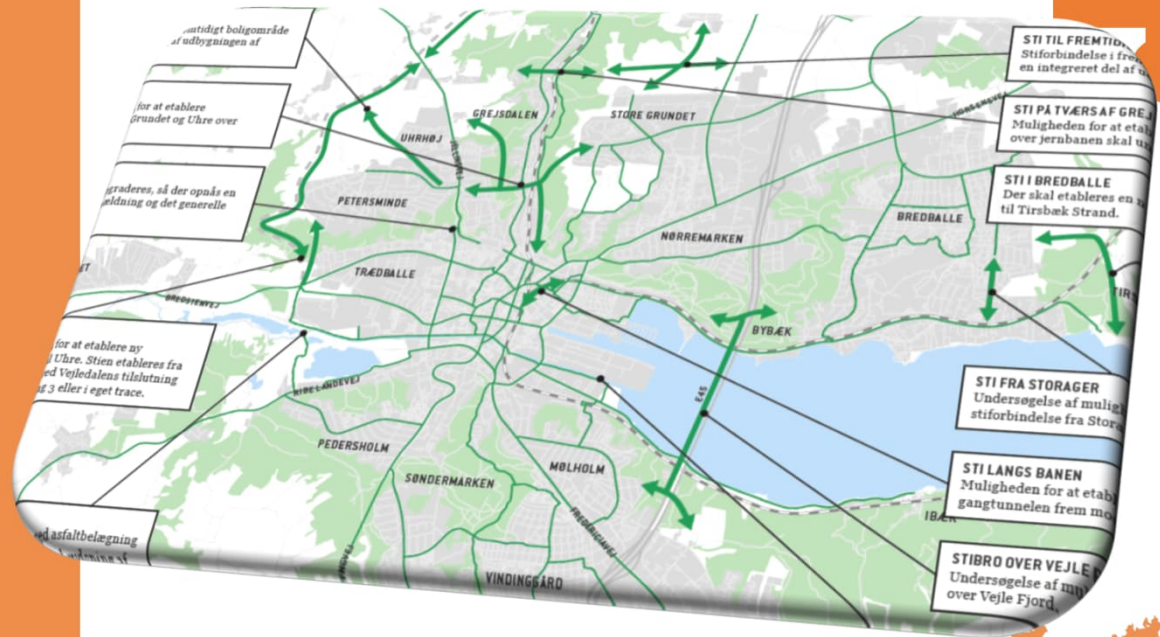

Projekt & handlingsplan

- Anlægsoverslag
- Investeringsplan
- 1.4 mia. 160 mio.



Politiske beslutninger

- Skitseprojektering
- Skitseforslag
- Anlægsbevilling



Visualisering

- 8 skitseforslag
- Stiforbindelser
- Bro eller tunnel
- Forbinde to bydele
- Sikker krydsning af jernbanen
- Topografi og udfordringer



Ny stibro i Grejsdalen

- Grejsdalen til sundhedsskoven
- Oplevelsesrig placering
- Udflugtsmål
- Blødt S formet forløb
- Forcer bar integrering



Samarbejde



- ✓ Løsningsorienteret
 - Eksempler:
 - Trafikafvikling
 - 21 aftalesedler
 - 25 forespørgsler
- ✓ Fælles tilsyn i Polen
- ✓ God løbende dialog
 - ↓
 - ✓ Hurtig responstid fra bygherre/rådgiver
 - ↓
 - ✓ Flexibilitet ved afvigelser og tilpasninger på byggepladsen

Planlægning

- ✓ 3D model med pilhøjde
 - opmærksomhedspunkter

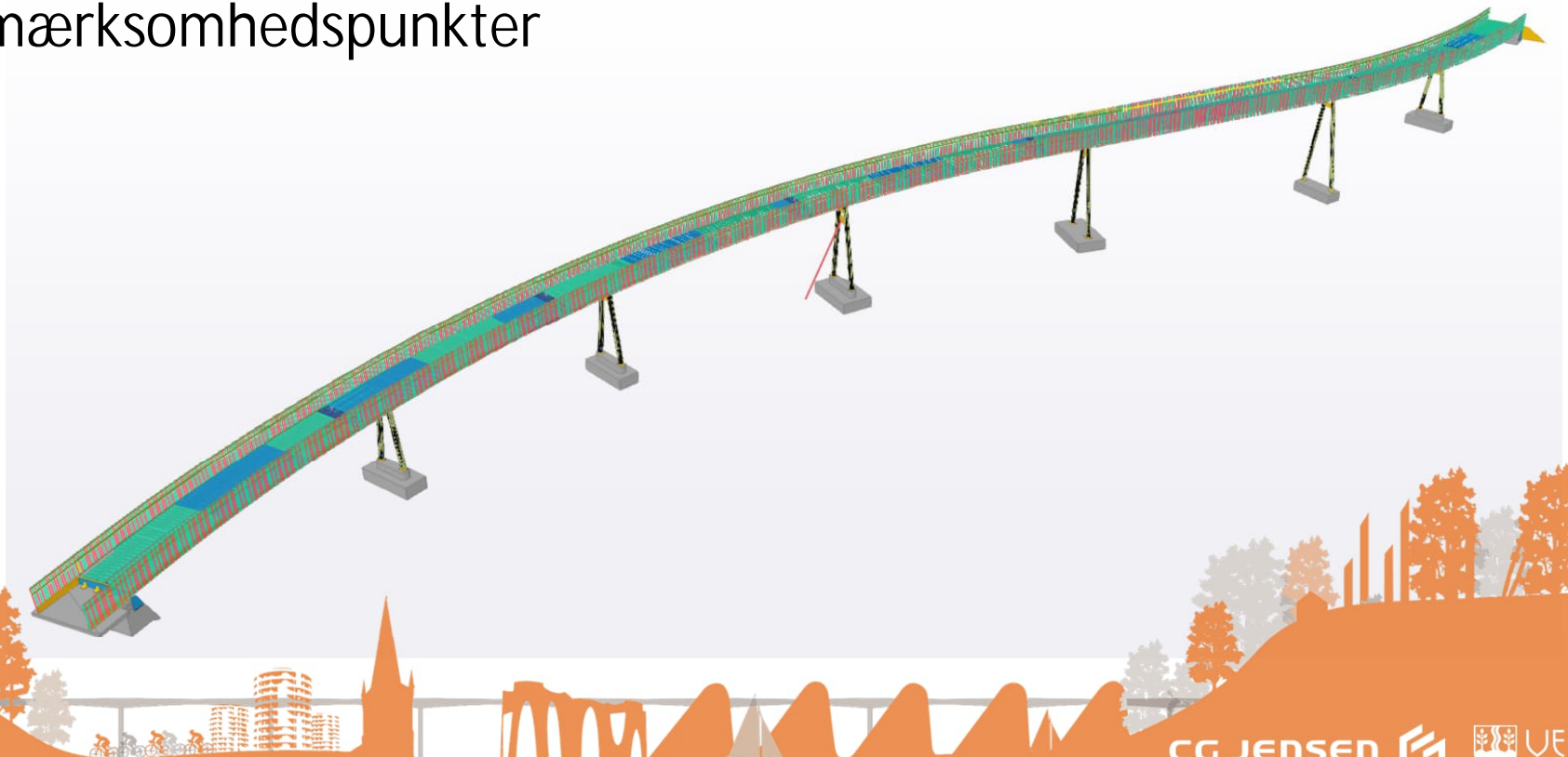

Planlægning

- ✓ Anvendelse af droneoverflyvninger og pointclouds

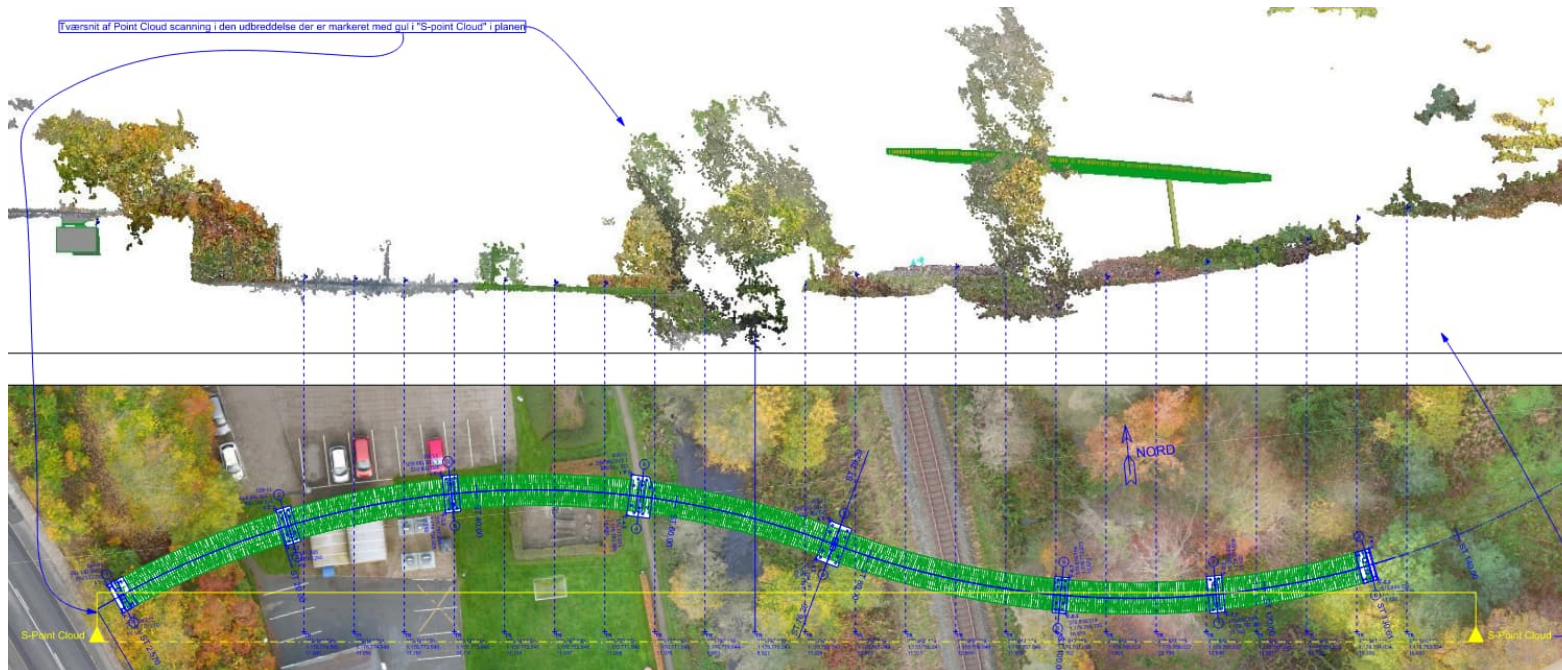

Planlægning

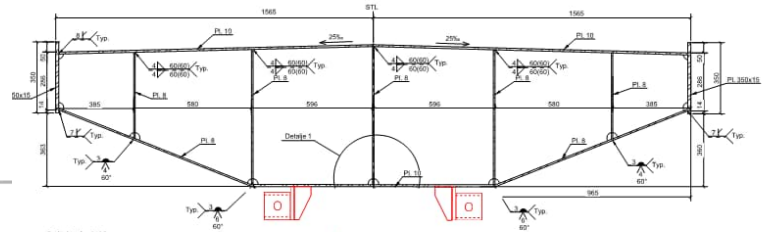
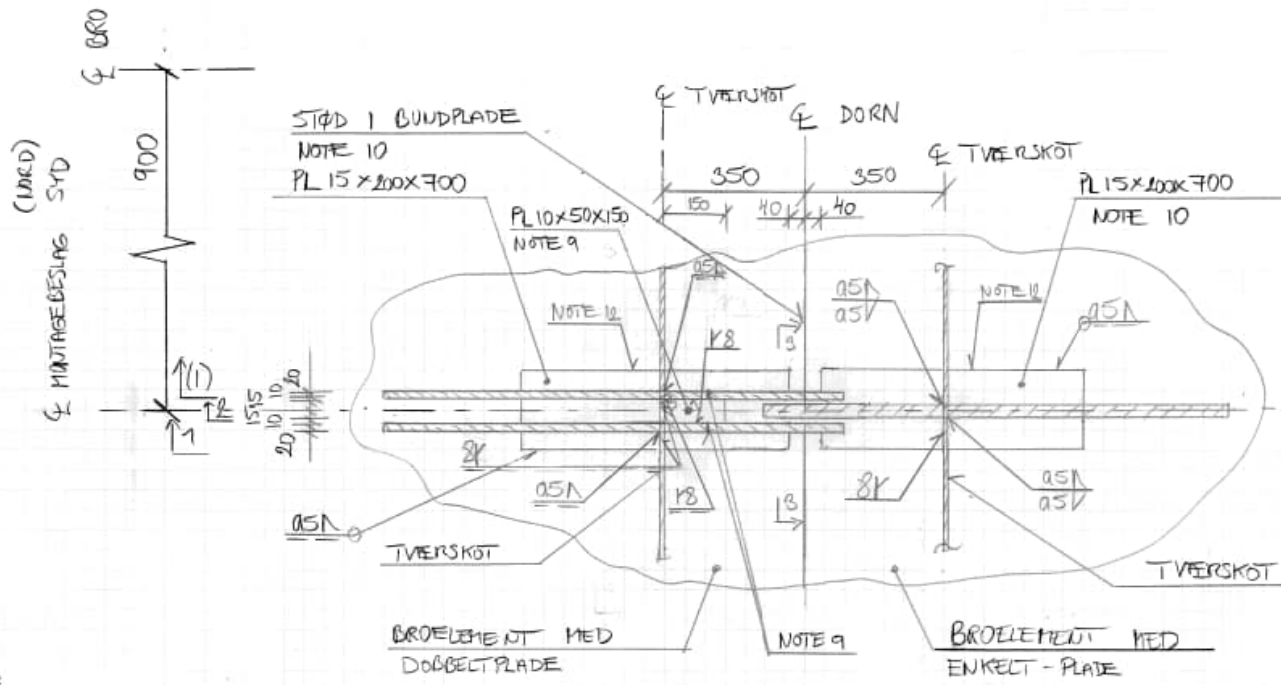

Snit A-A 1:10
Se tegning 21 og P.P. for svejseanordninger mellem tværskøt og broelement.

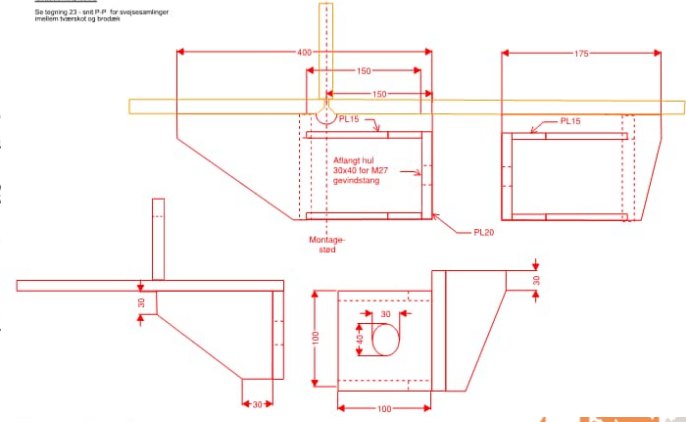

Planlægning

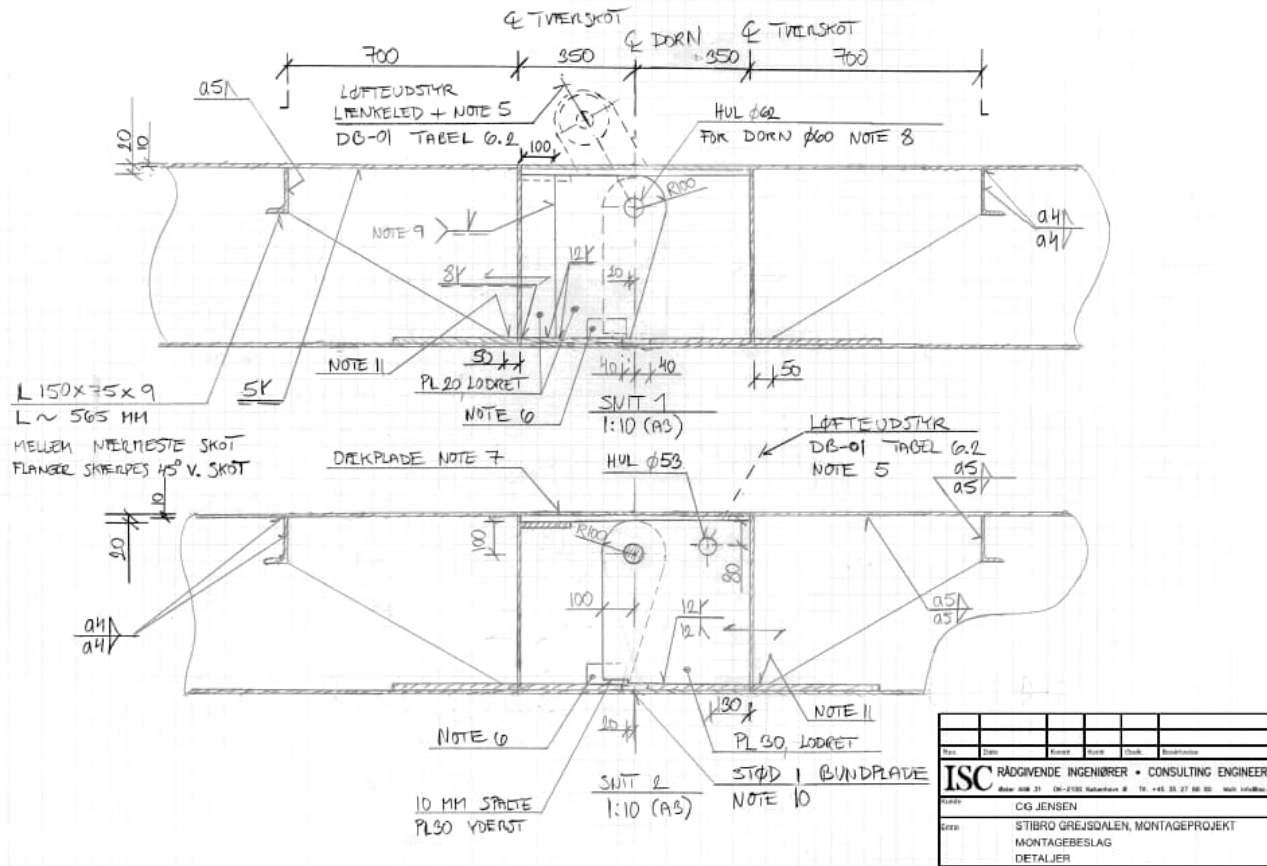

Vejles svar på Cykelslangen
 Dansk Brodag 9. april 2024

Planlægning

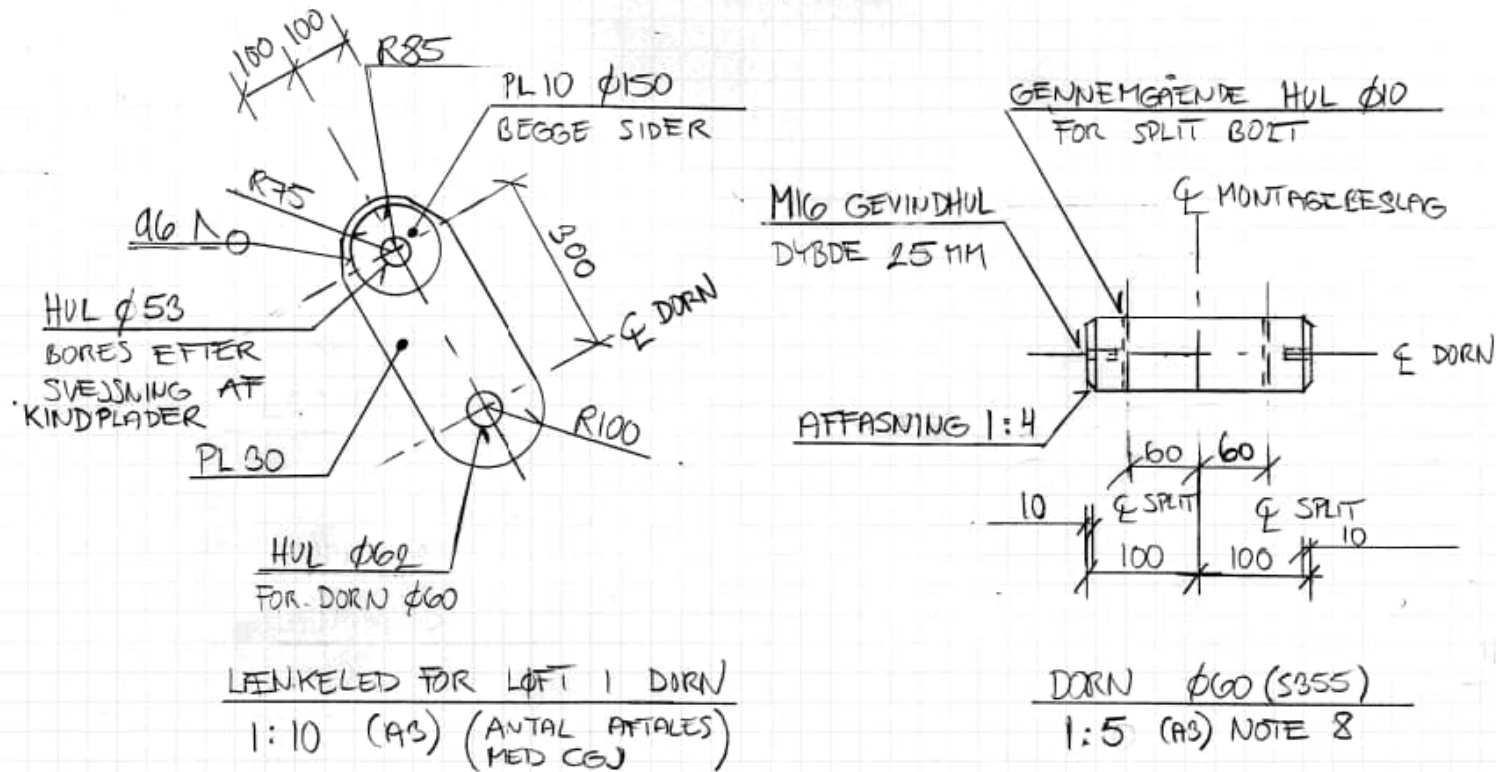

Planlægning

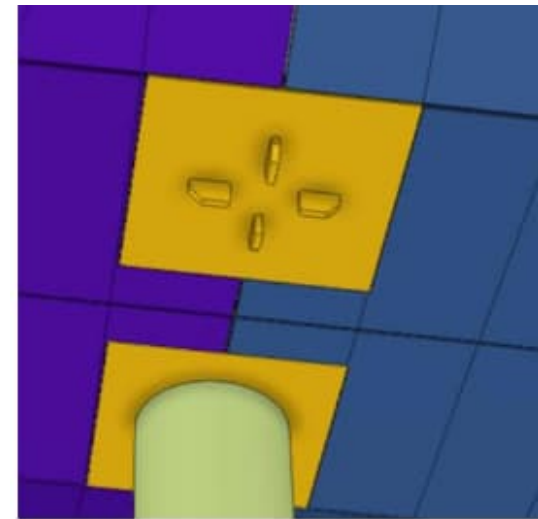
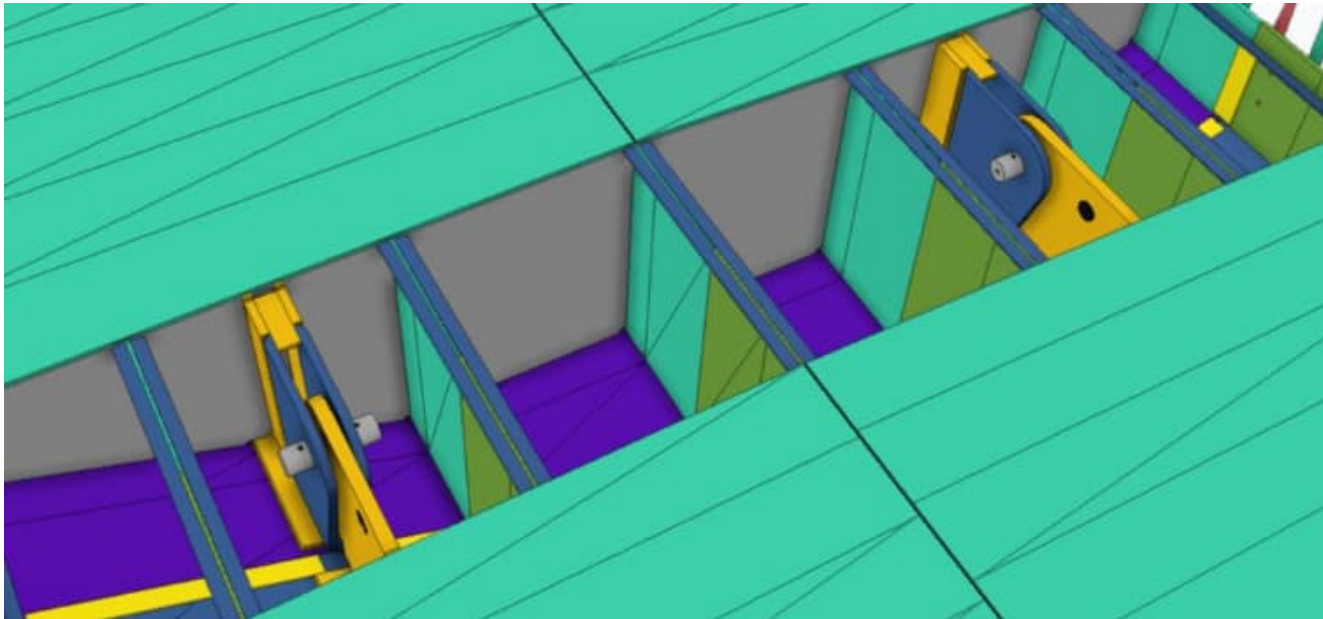
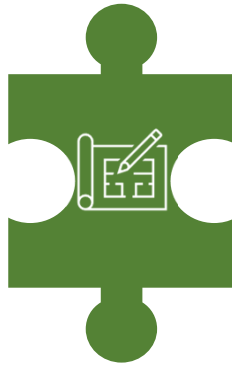

Planlægning



Planlægning

Transport fra Polen



Land vs. vand



DE vs. SE



Planlægning

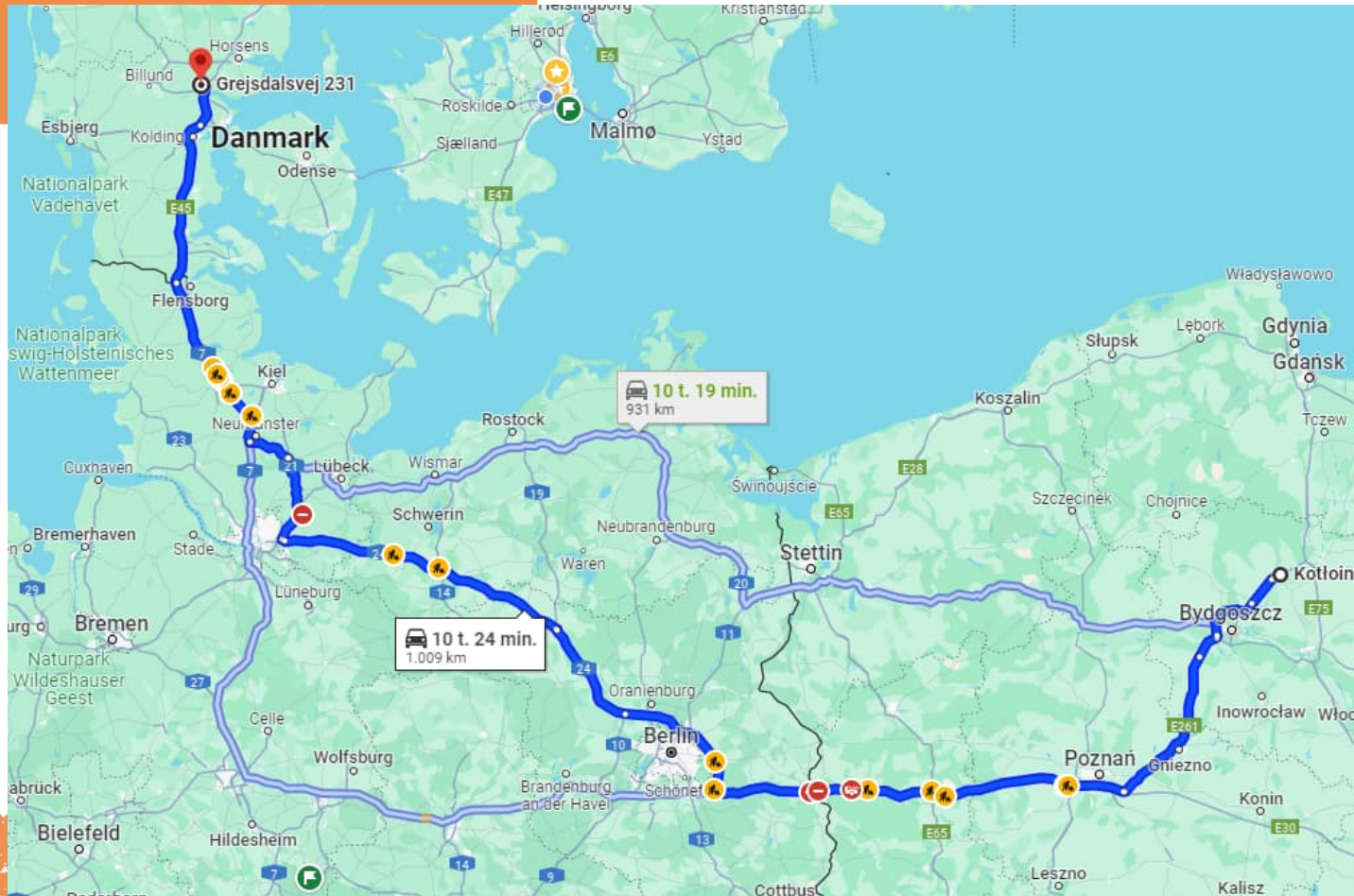
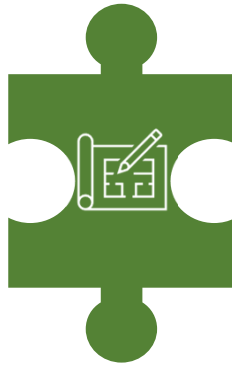

Vejles svar på Cykelslangen
Dansk Brodag 9. april 2024

Planlægning

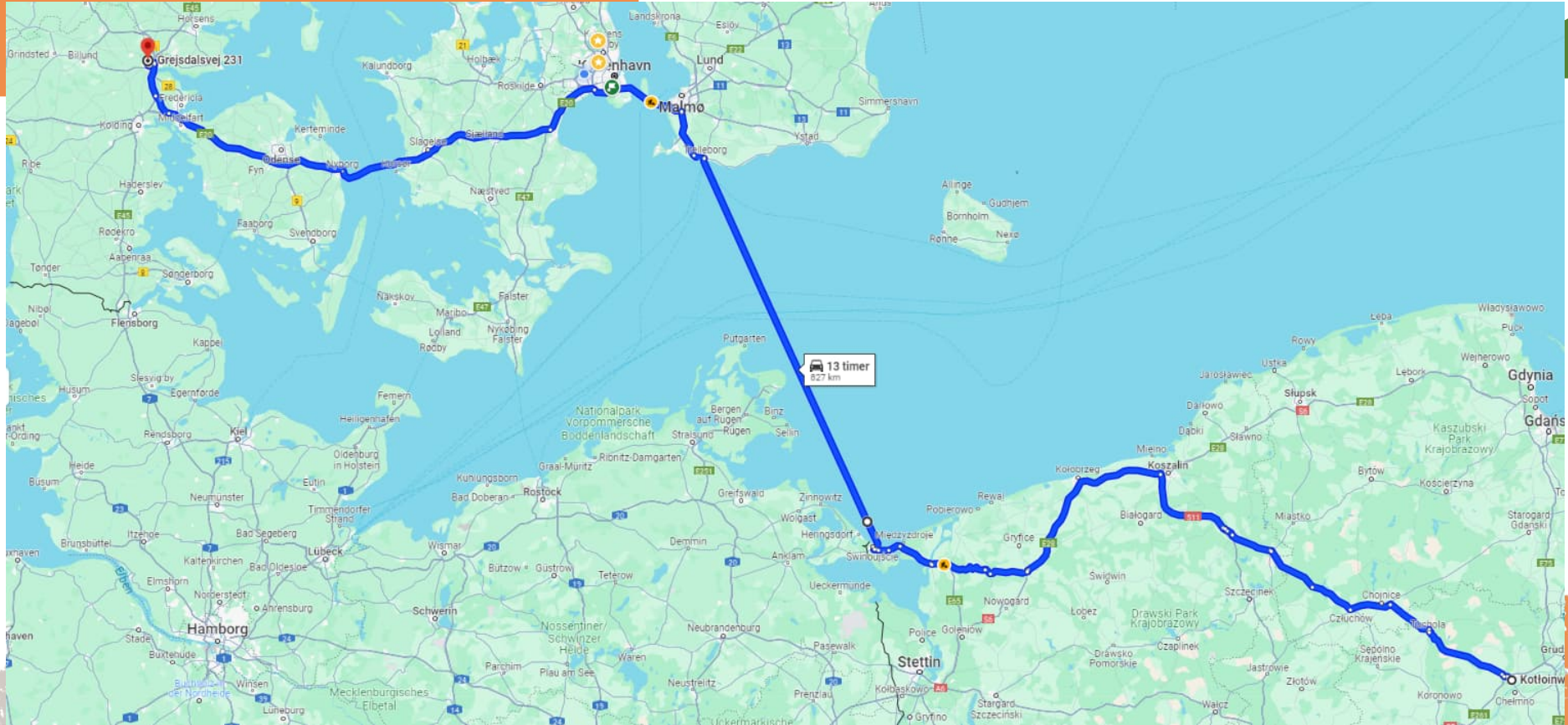

Vejles svar på Cykelslangen
Dansk Brodag 9. april 2024

Planlægning

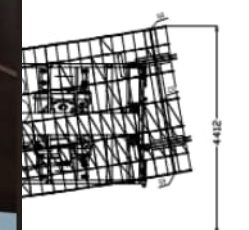
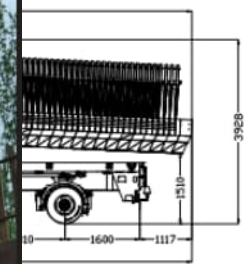
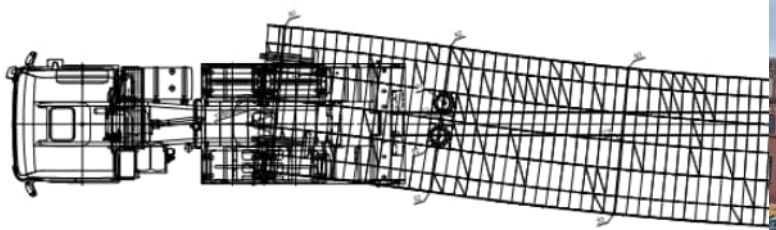
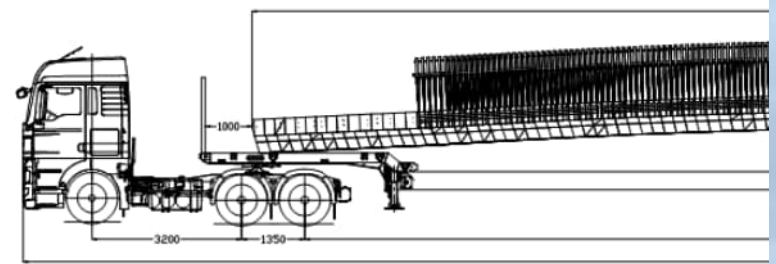

Geometri

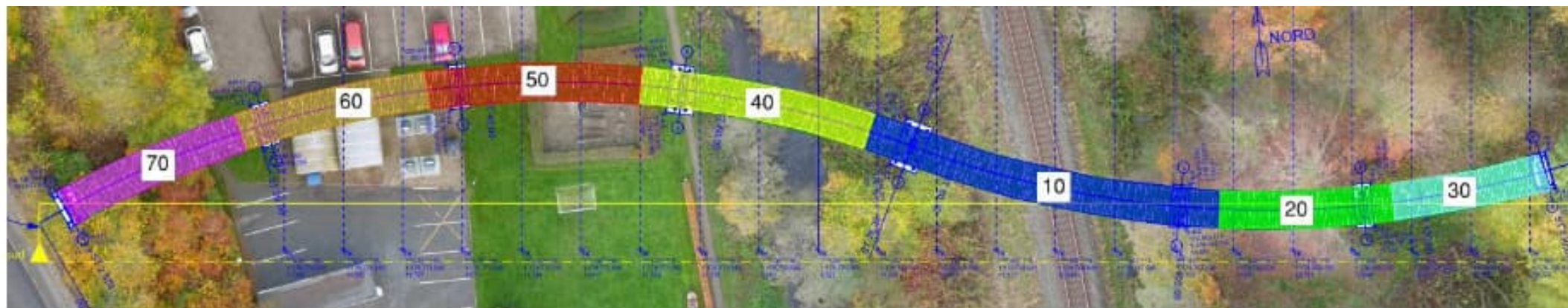

Geometri

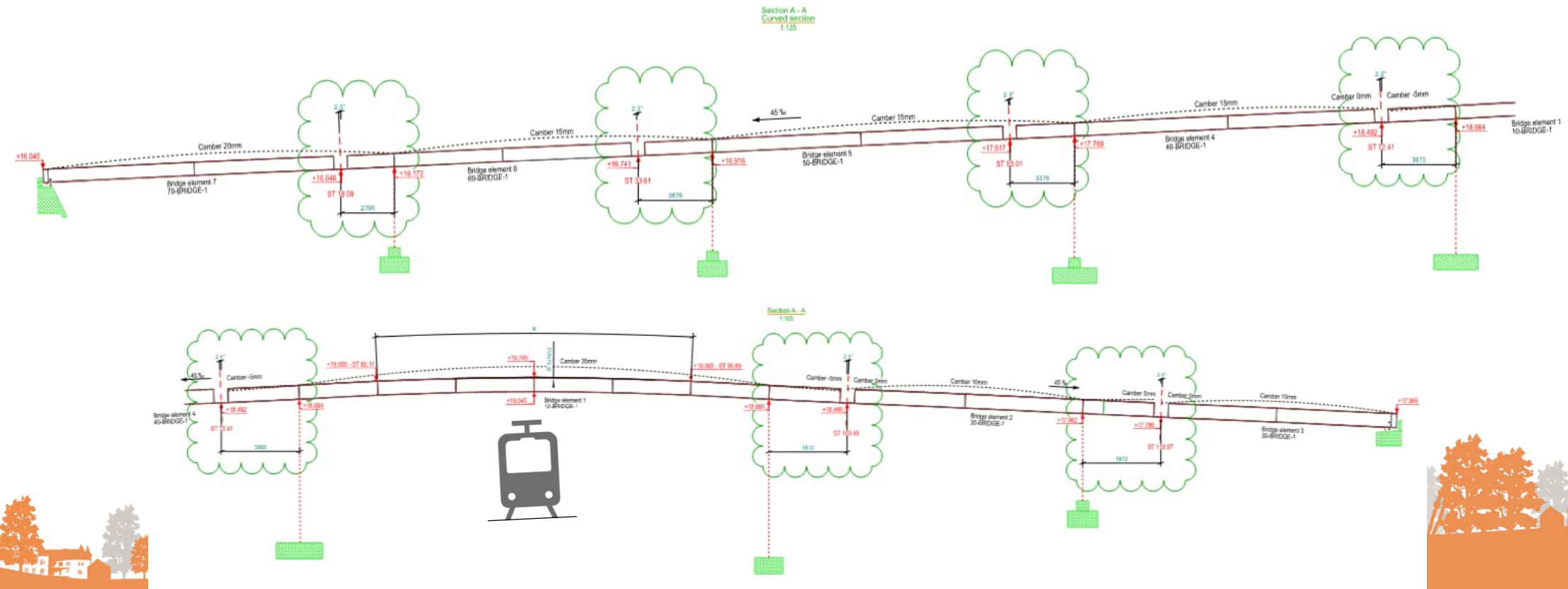

Tværsnit

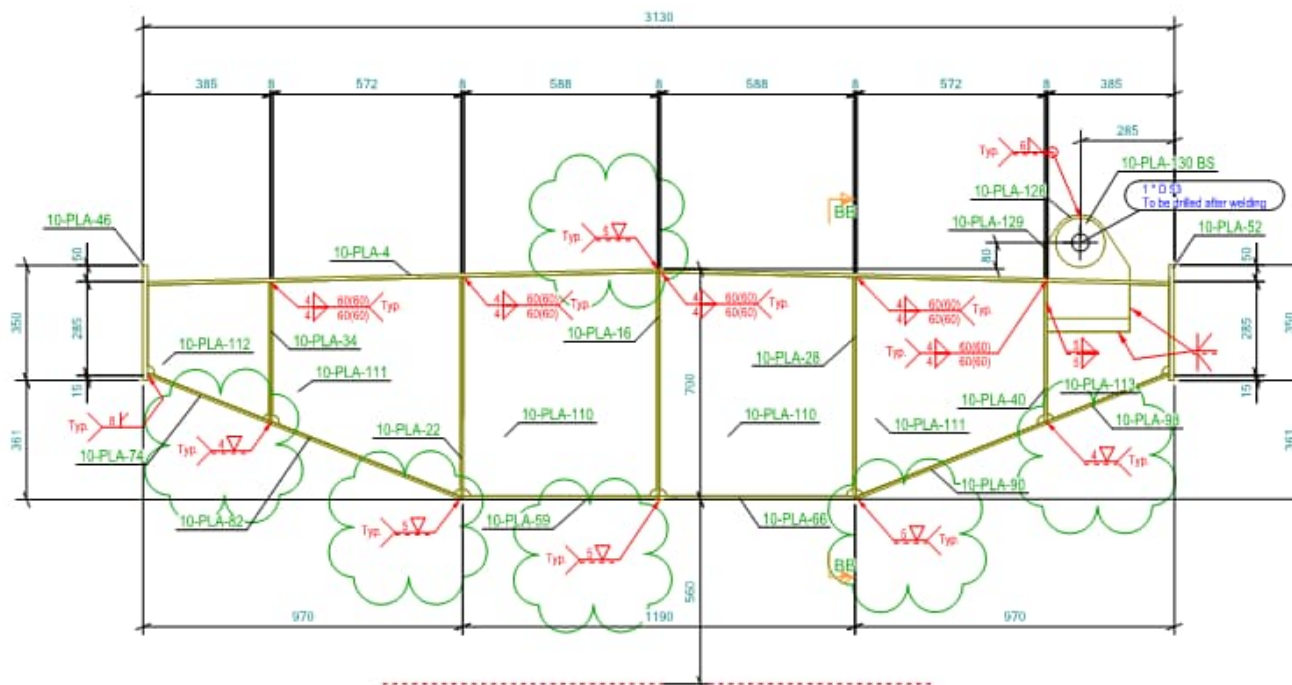
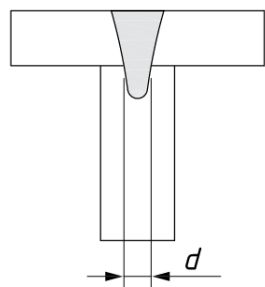

Tværsnit

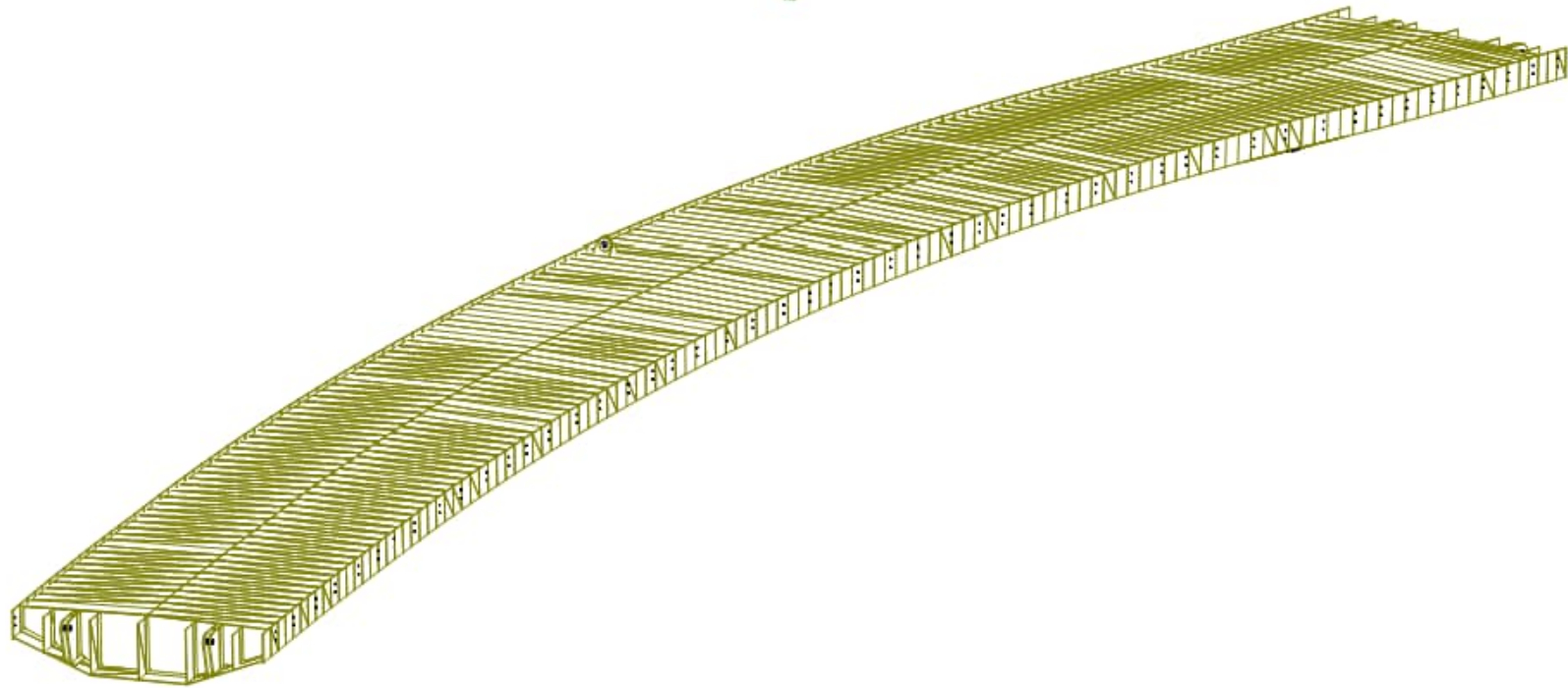

Svejsesekvens

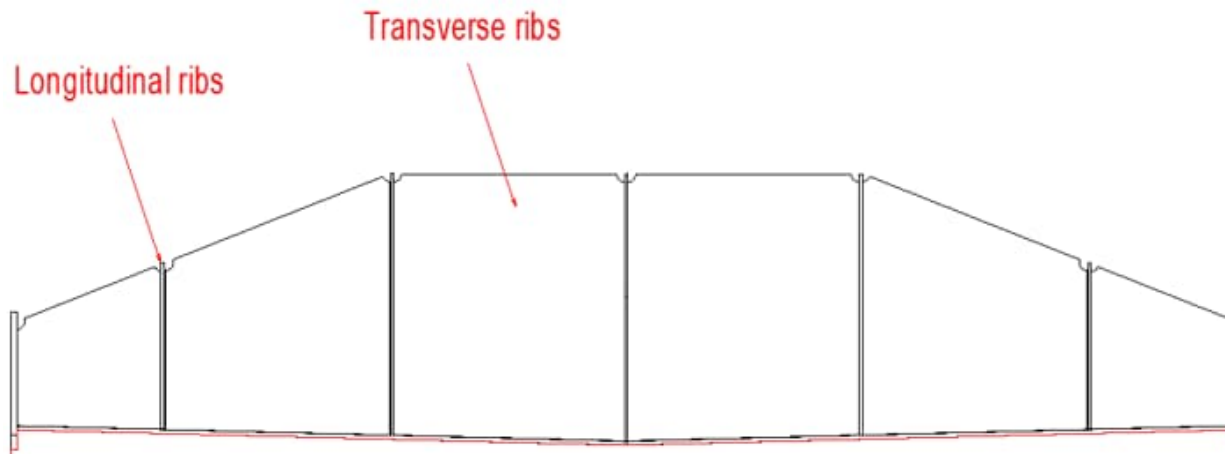

Svejsesekvens

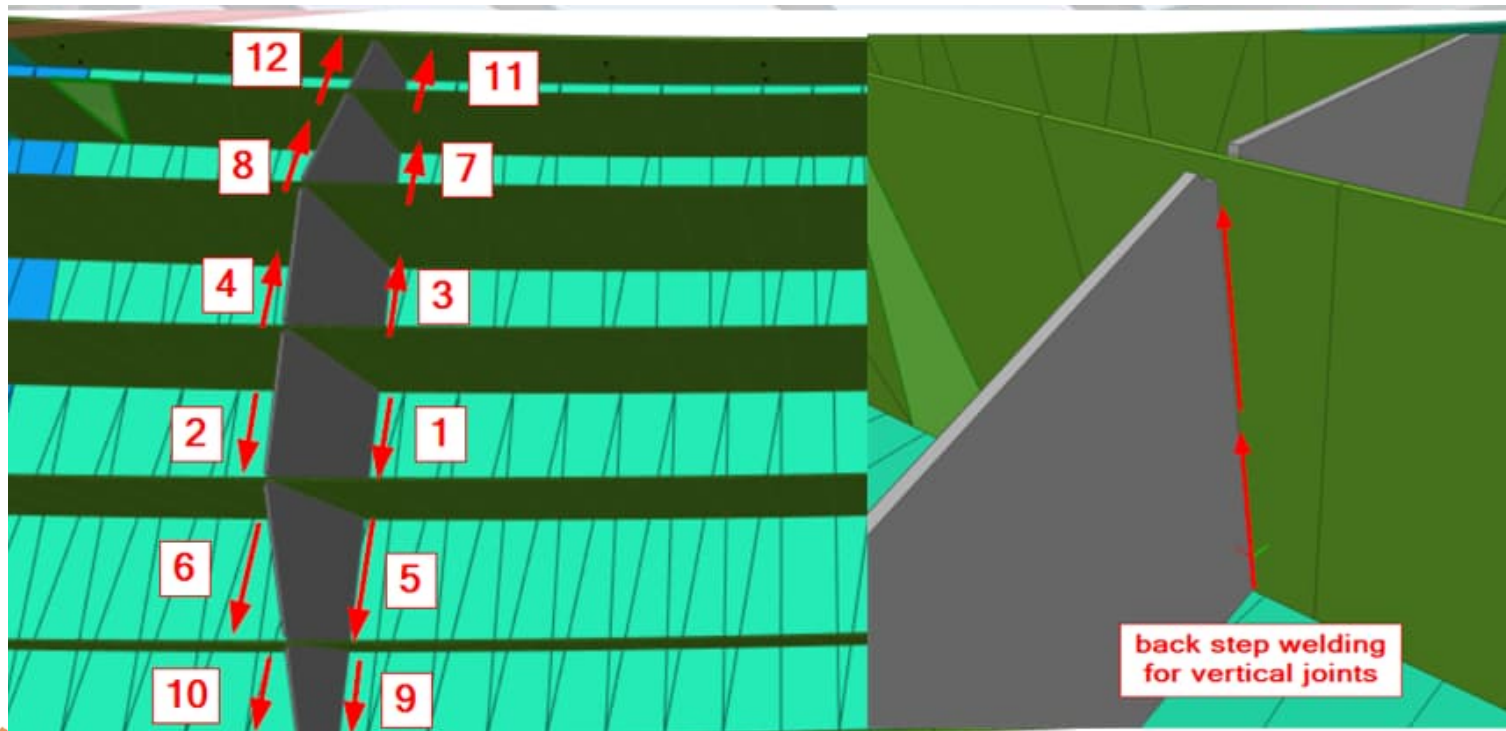

Svejsesekvens



Closing plates

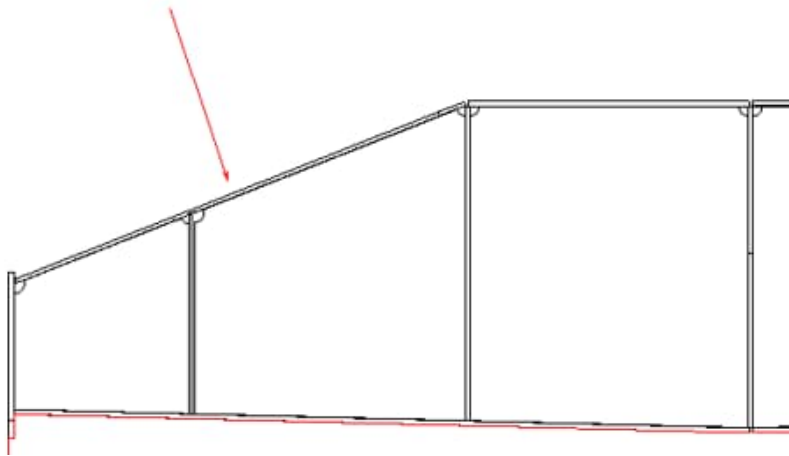

Prøvesamling 10+40



Prøvesamling 60+70

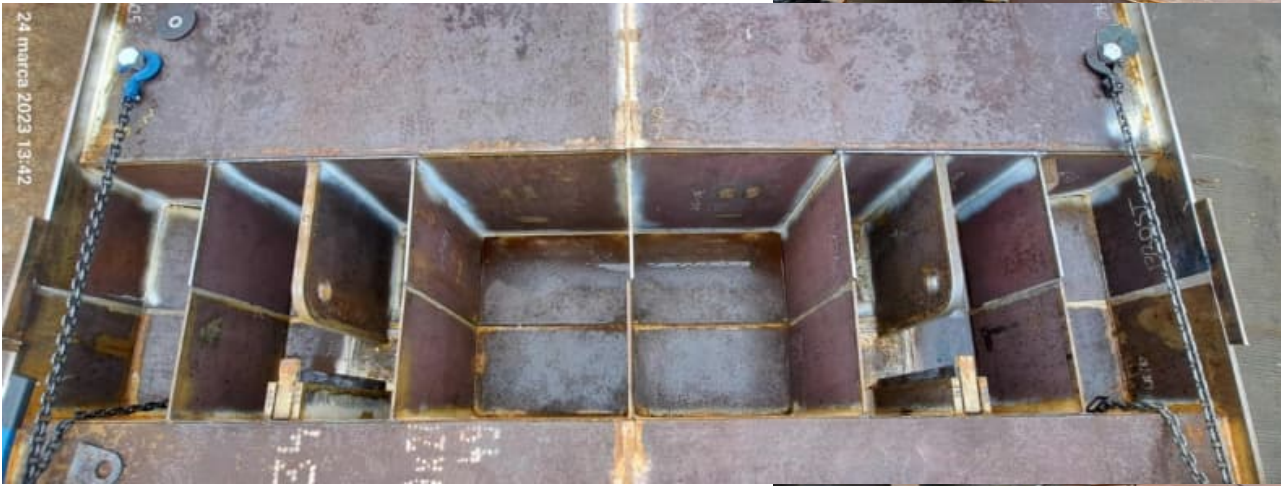

Rækværker



81-PRO-3 = 81-PRO-4: (O) top turned counter clockwise
81-PRO-5 = 81-PRO-6: (X) top turned clock wise

2085 stk.
vredne
sceptre
PL6x50

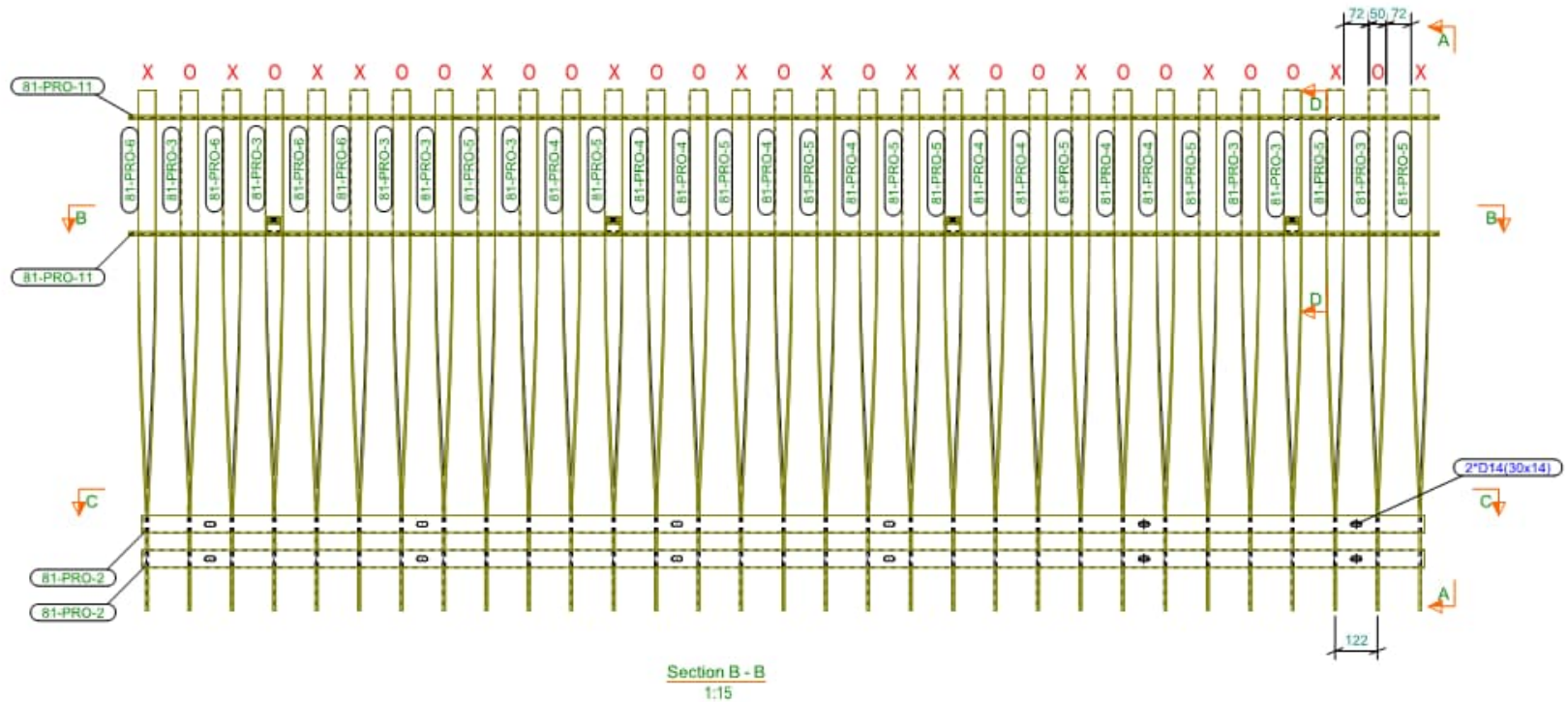

Rækværker



Håndlister

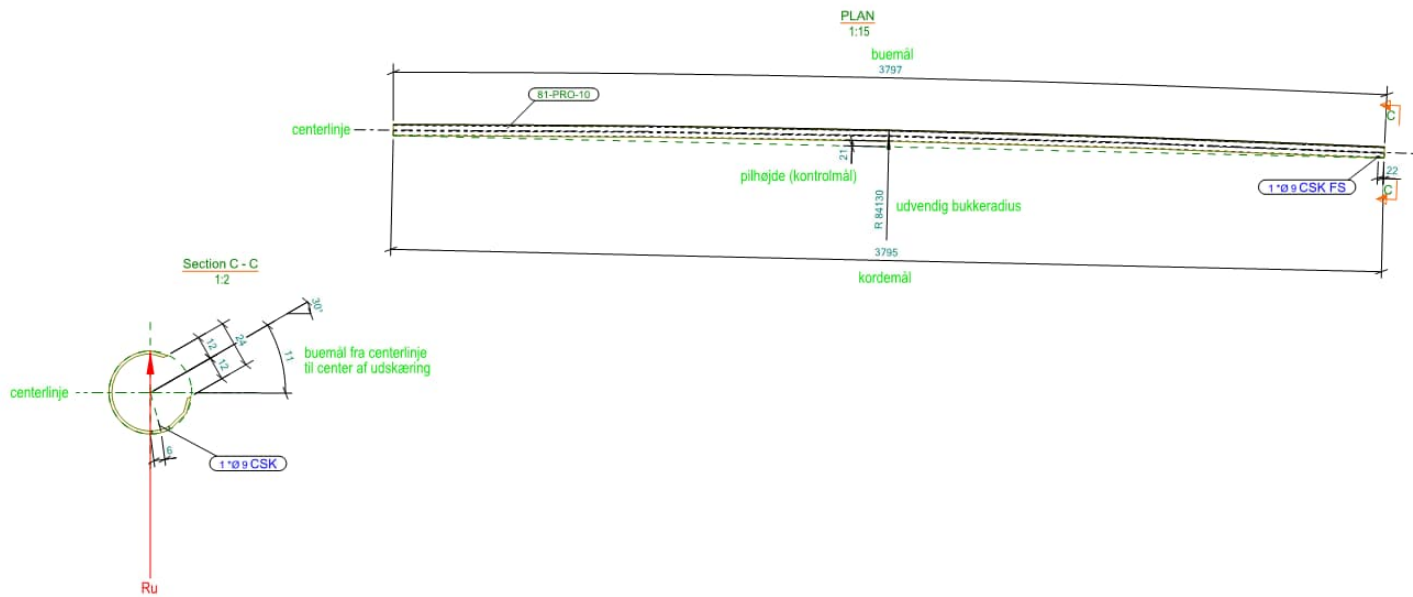

Rækværker & håndlister



Håndtering og transport af elementer



Montage

- Søjler

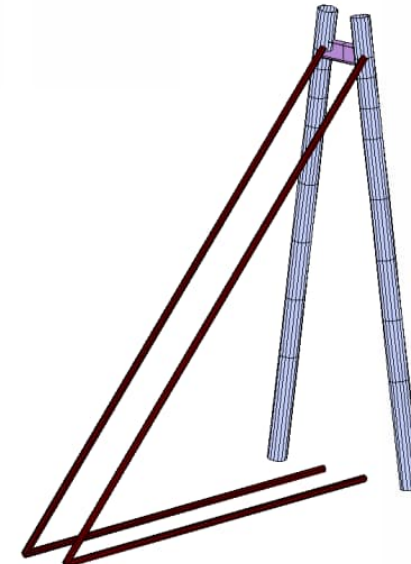
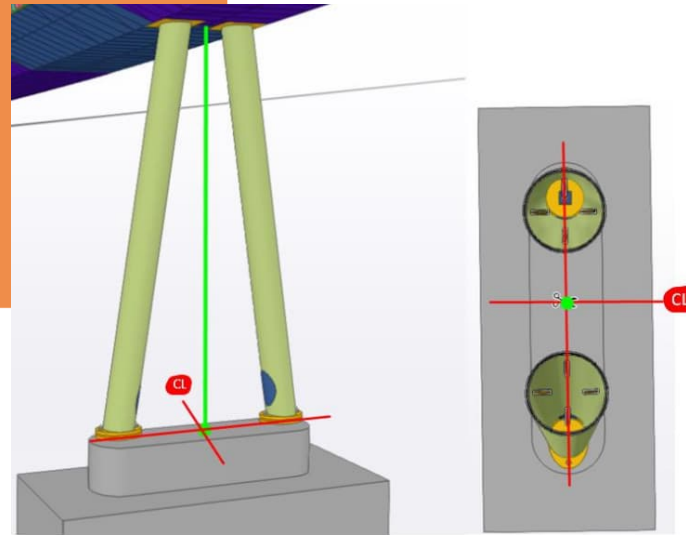

Figur 4-2: GTStrudl-model, isometri

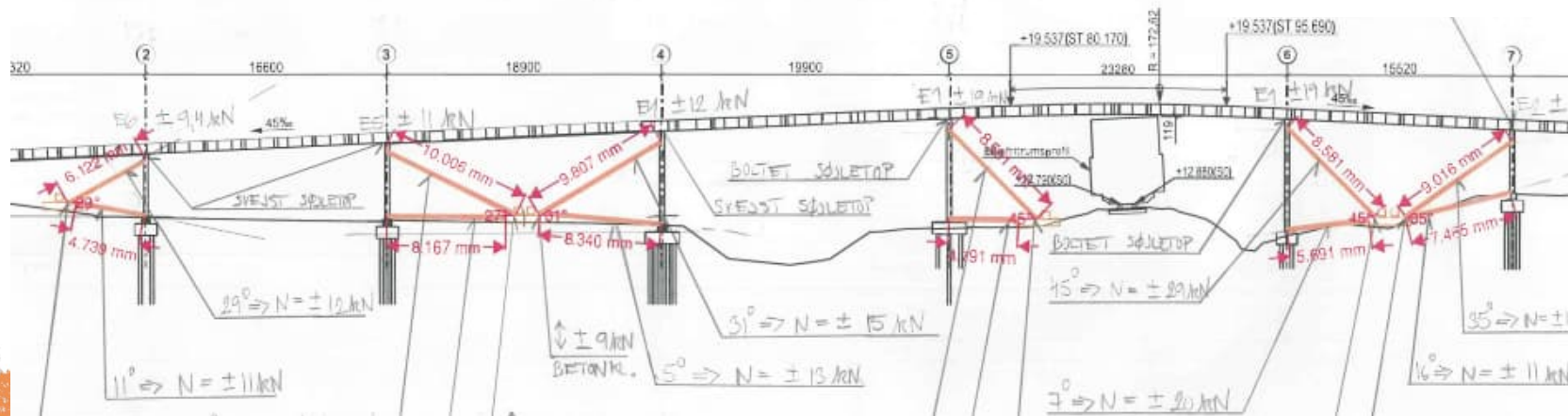
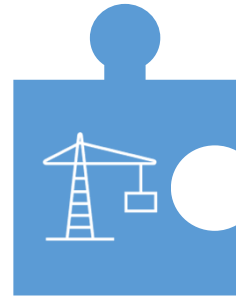

Montage

- Søjler

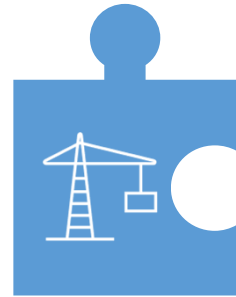
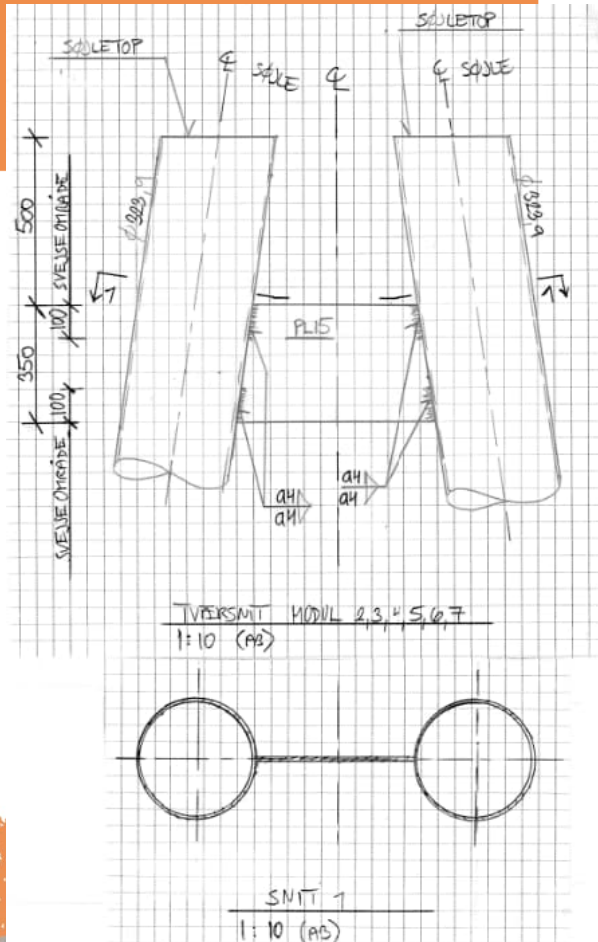

Montage

- Brolejer
- Sfæriske KGA og KGE lejer

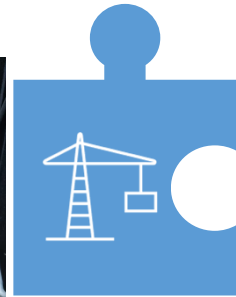
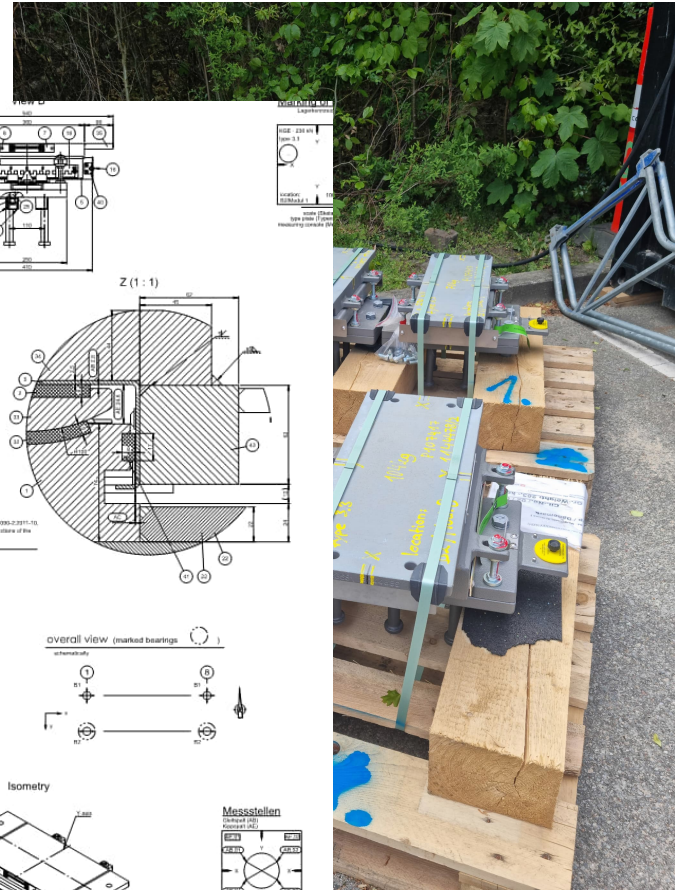
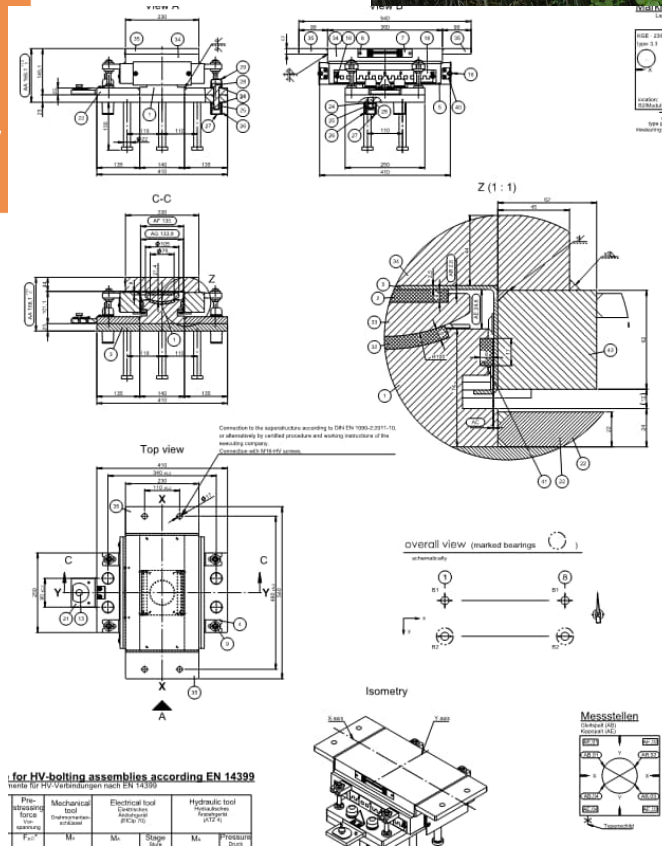

Montage

- Løftekonfigurationer

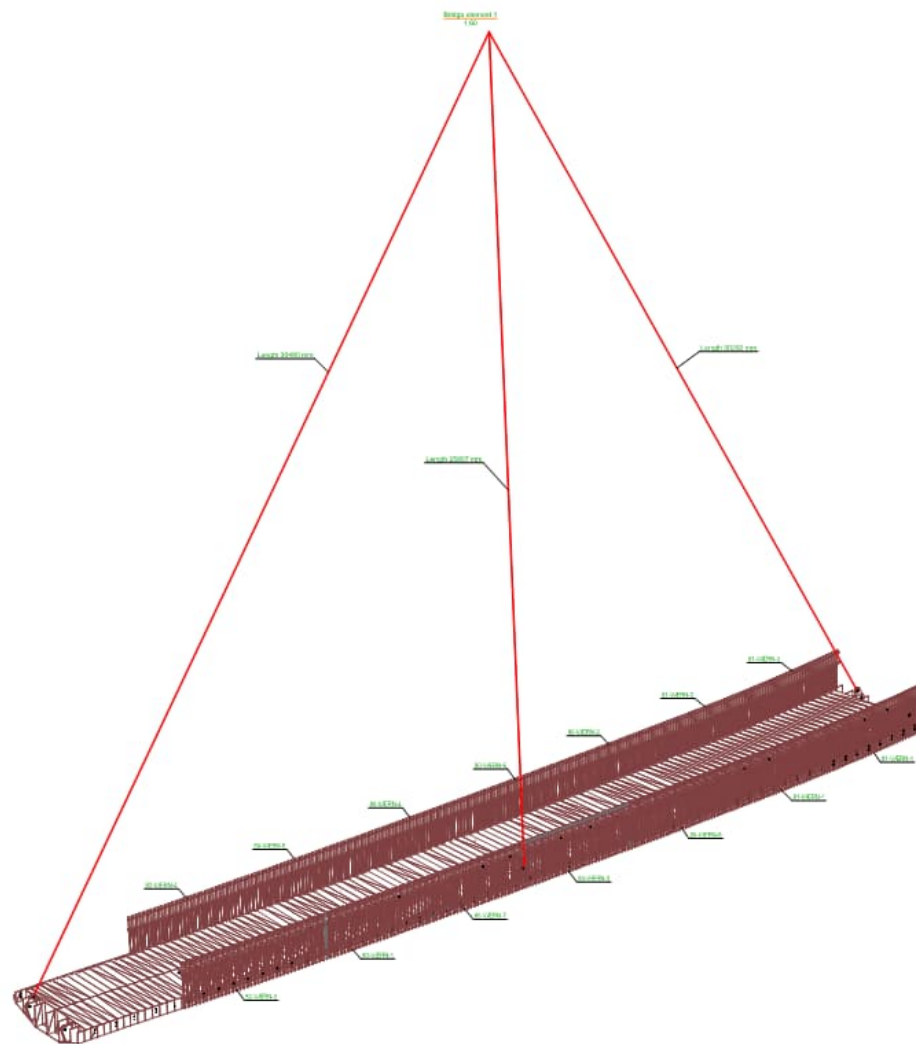
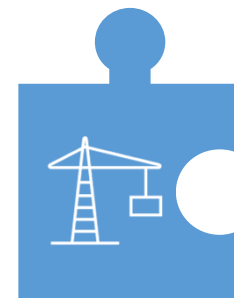

Montage

- Løftekonfigurationer

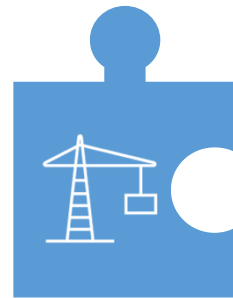

Montage

- Løftekonfigurationer

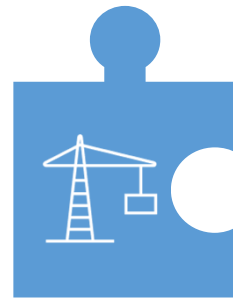

Montage

Mobilkran

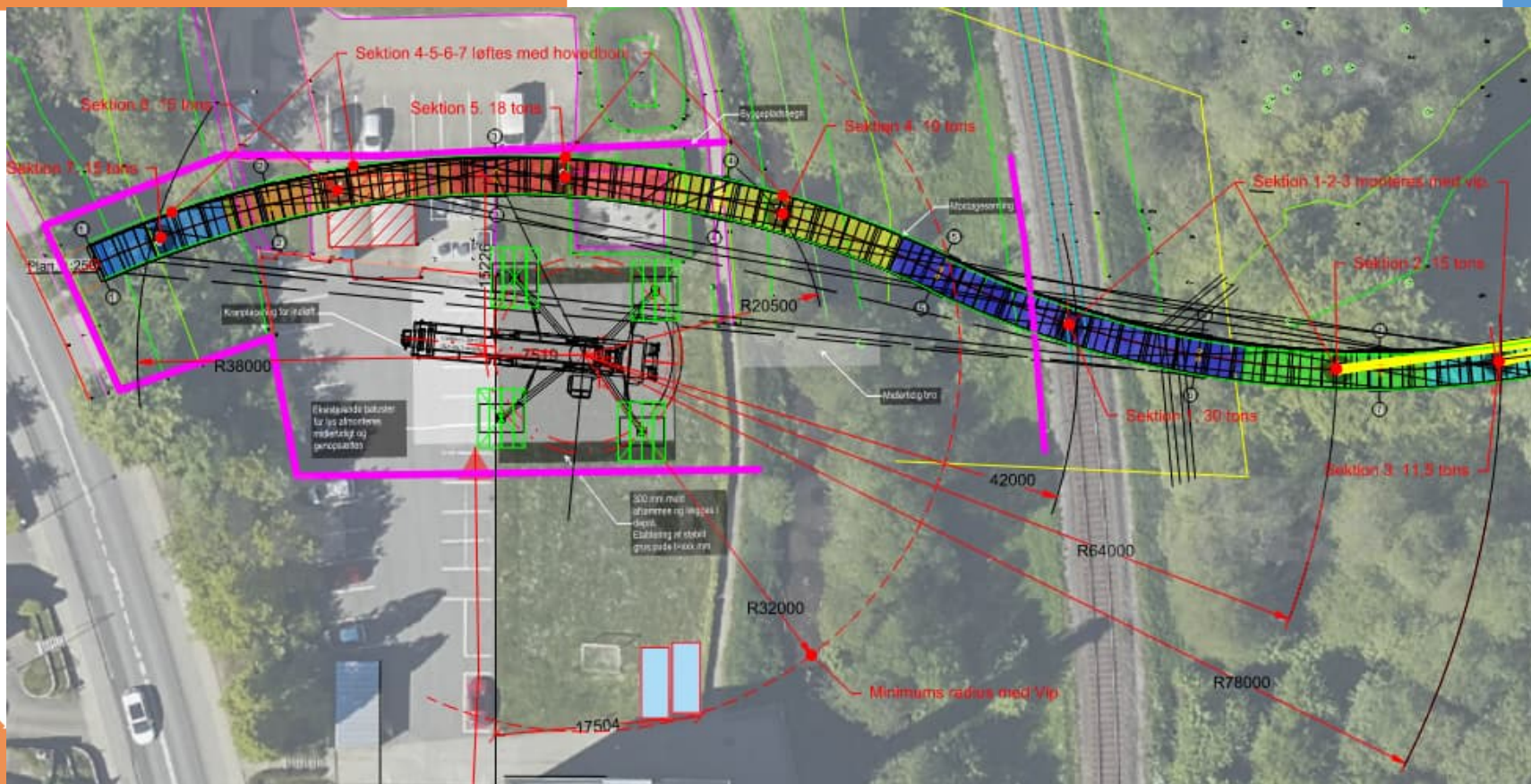

Montage

Mobilkran

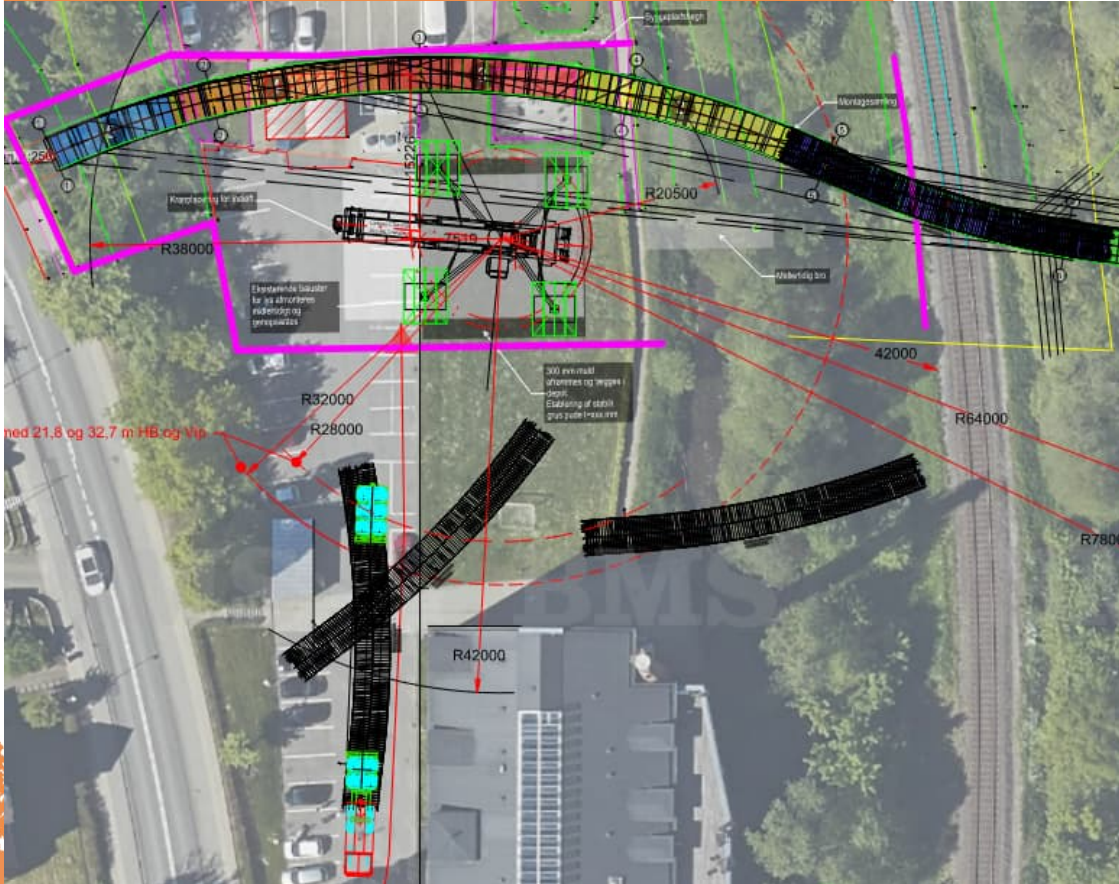
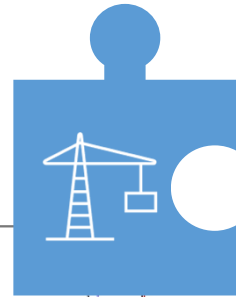

Montage

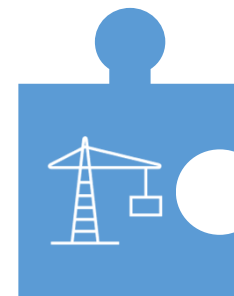

Vejles svar på Cykelslangen
Dansk Brodag 9. april 2024

Montage



Montage

- Montagestød

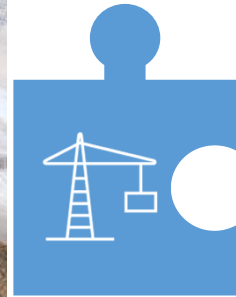

Montage

Som udført indmåling

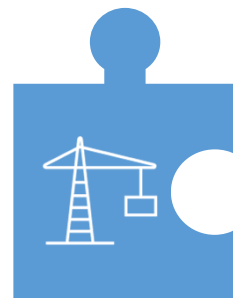

Nominering

Nordic Bridge Price 2024

Spørgsmål ?